

(1 : 20)

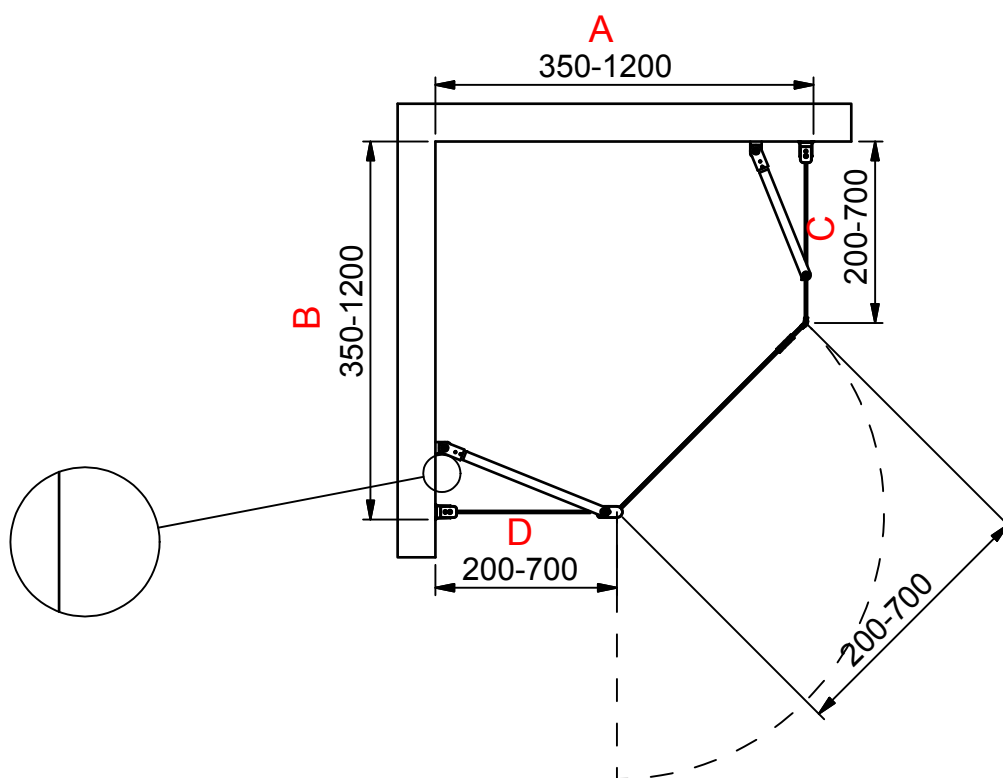
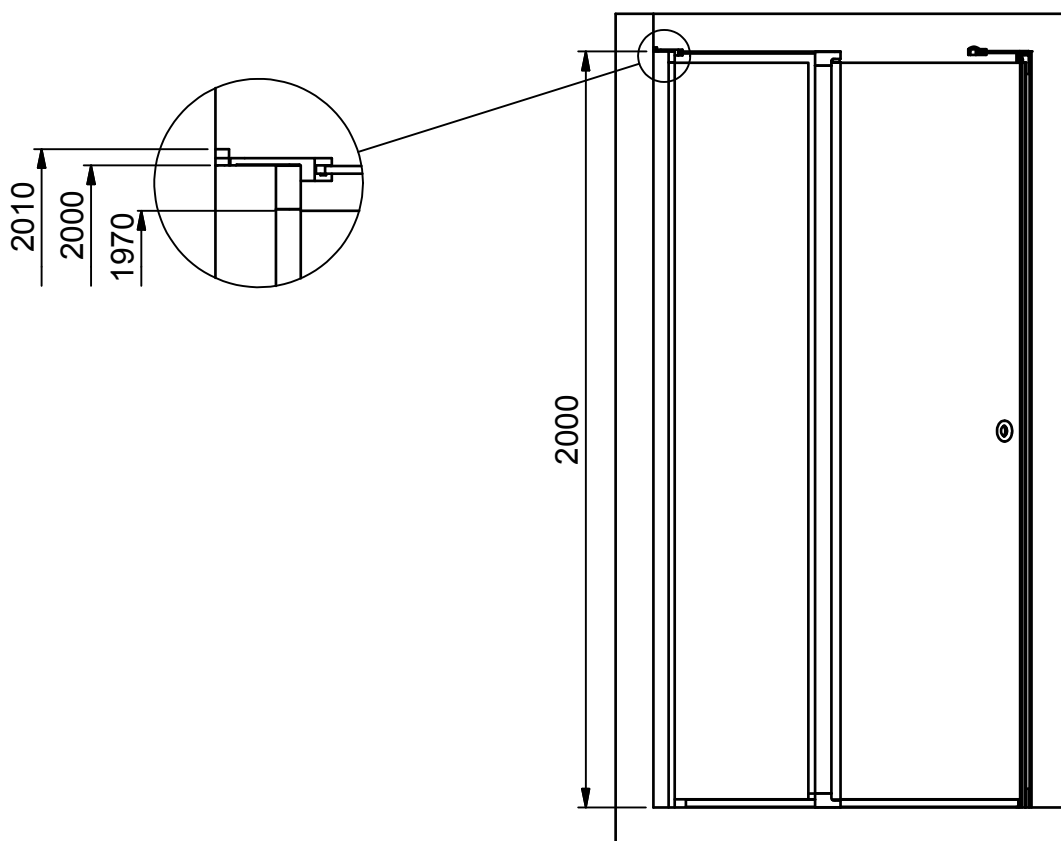

INR

Beskrivning
LINC Model 9 Left

Ritad av
CJN
Datum
2017-04-12

Ritningsnr
20013.01
Revision
B