

(1 : 20)

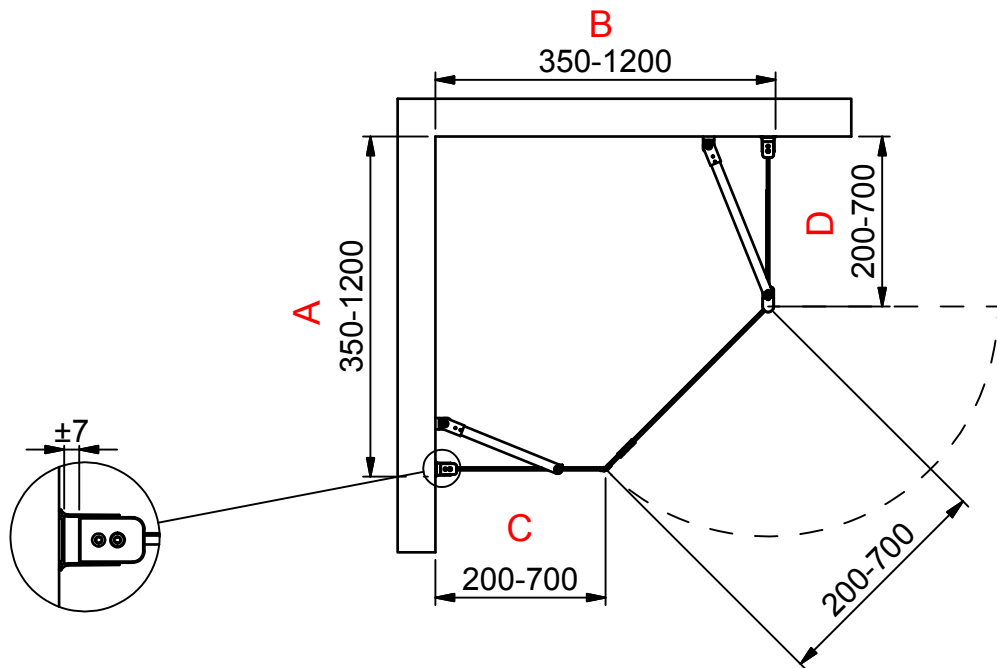
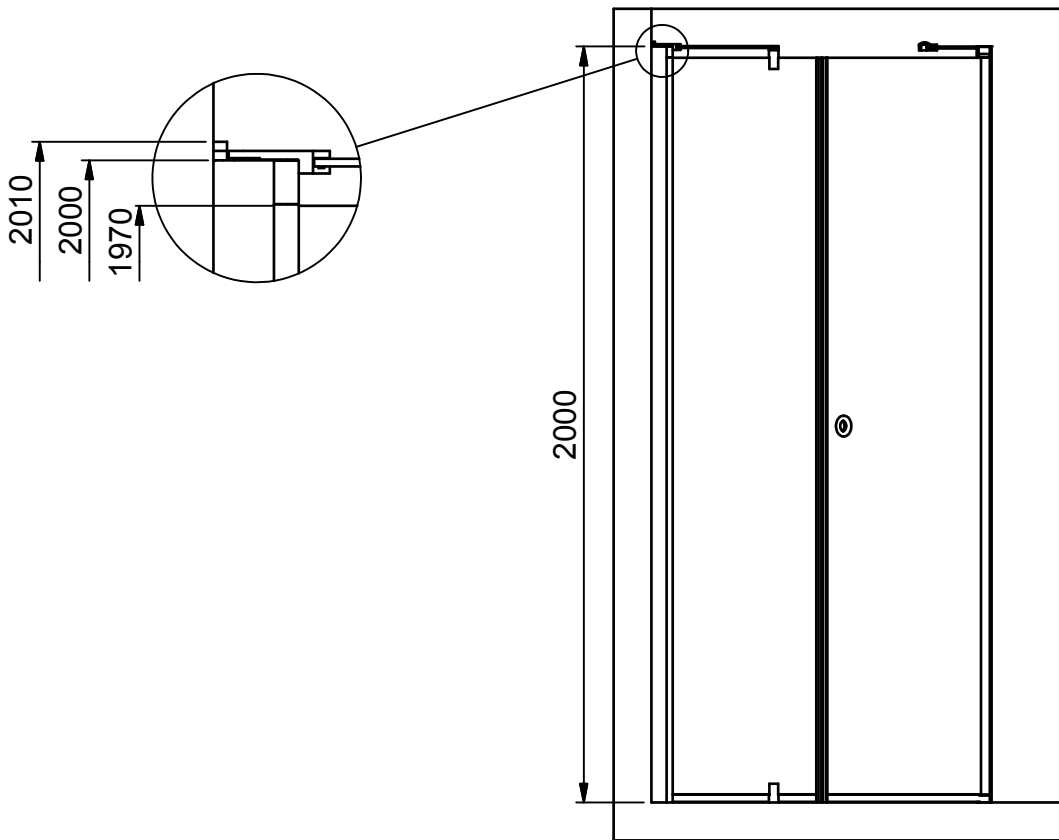

INR

Beskrivning
LINC Model 9 Right

Ritat av
CJN
Datum
2017-04-12

Ritningsnr
20014.01
Revision
B