

(1 : 20)

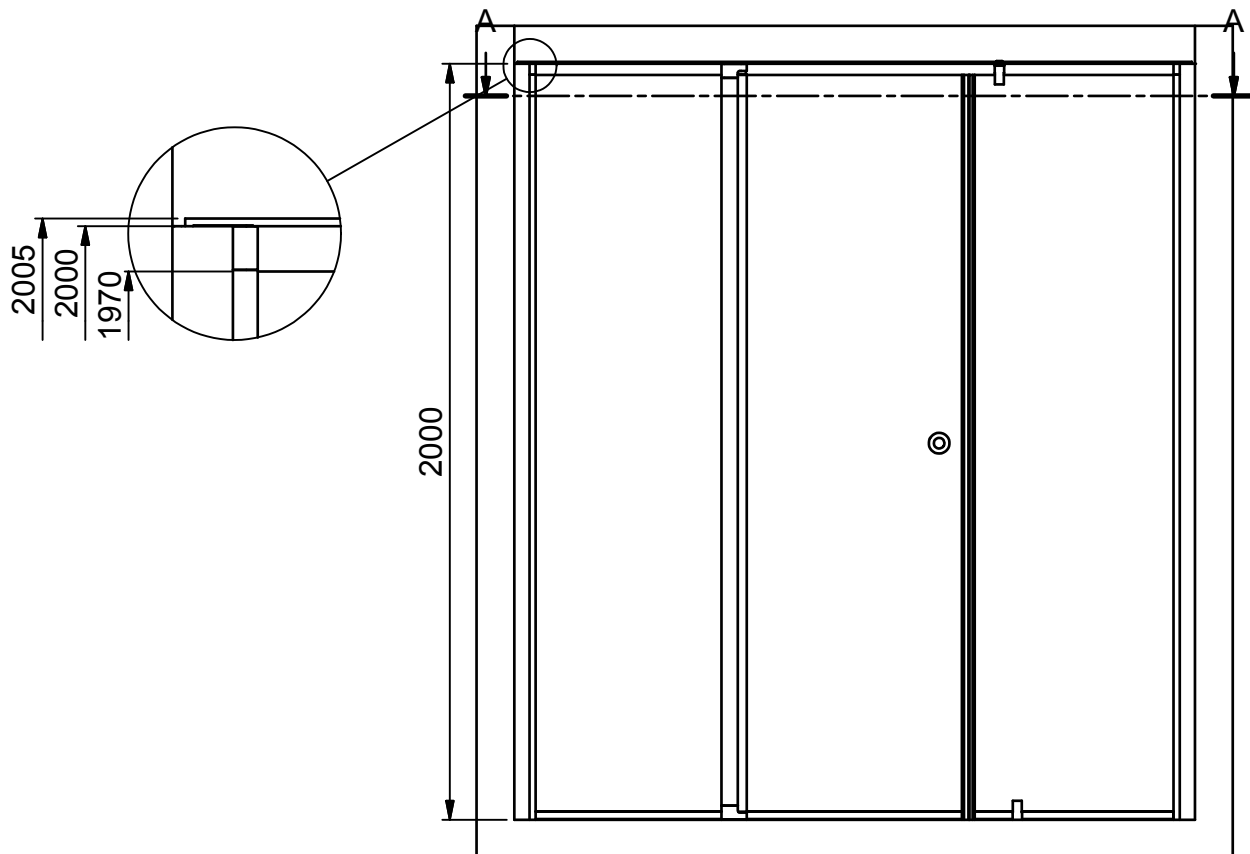

A-A (1 : 20)

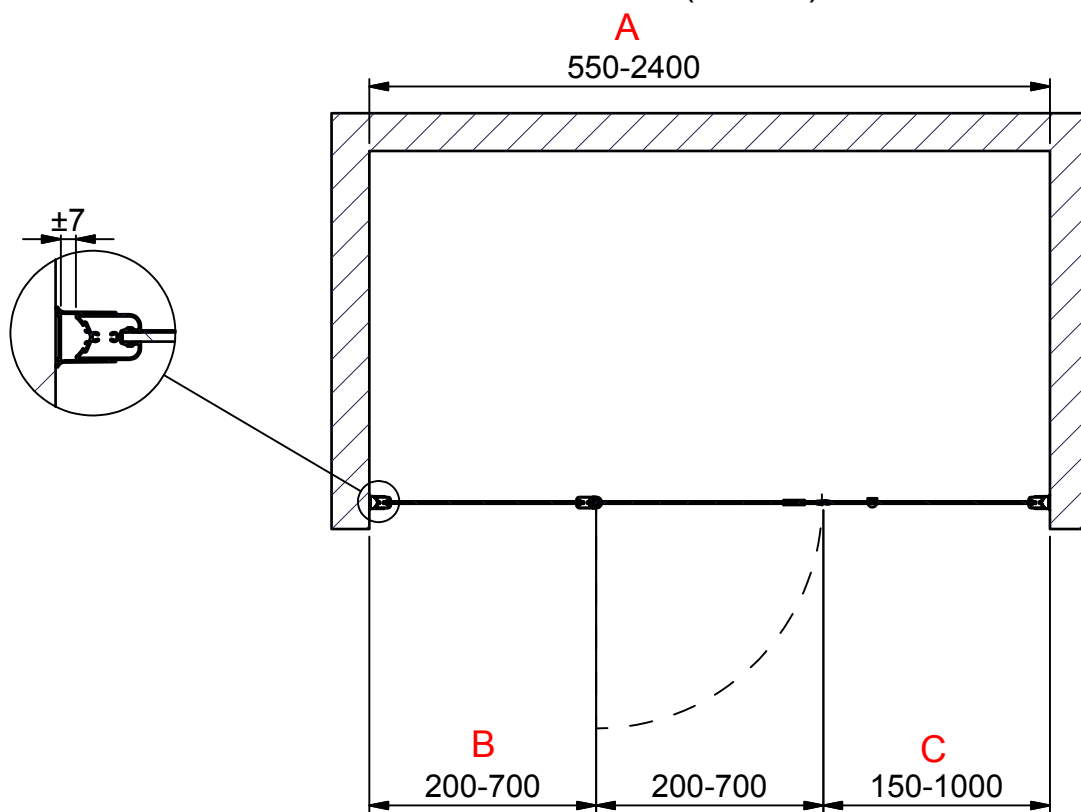

INR

Beskrivning
LINC Model 7 Left

Ritad av
CJN
Datum
2017-04-12

Ritningsnr
20010.01
Revision
B