

( 1 : 20 )

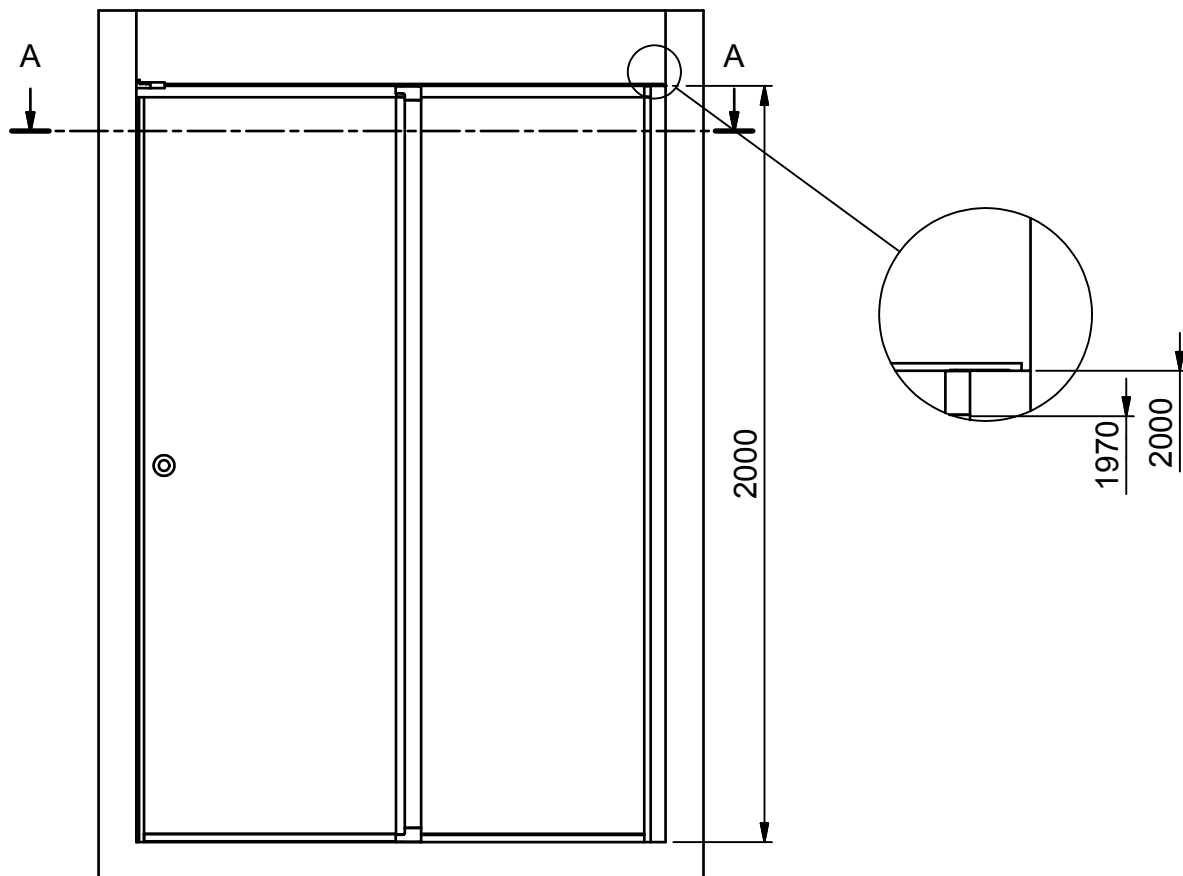

A-A ( 1 : 20 )

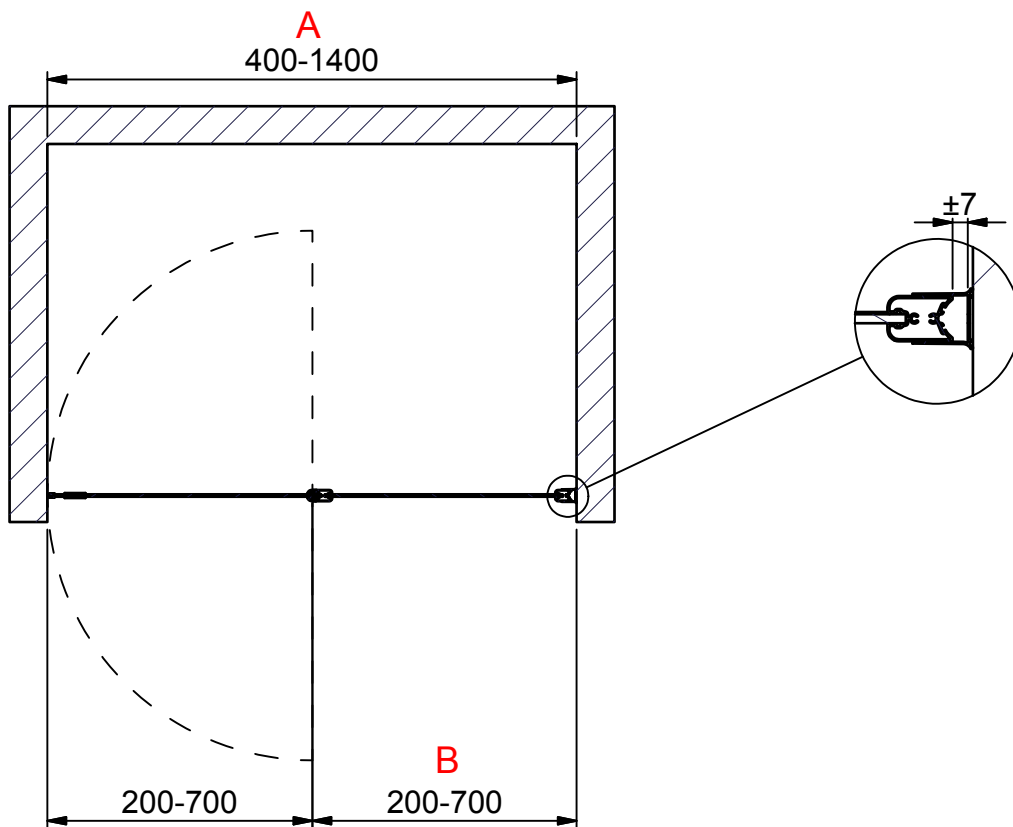

**INR**

Beskrivning  
LINC Model 5 Right

Ritad av  
CJN  
Datum  
2017-04-12

Ritningsnr  
20007.01  
Revision  
B