

(1 : 20)

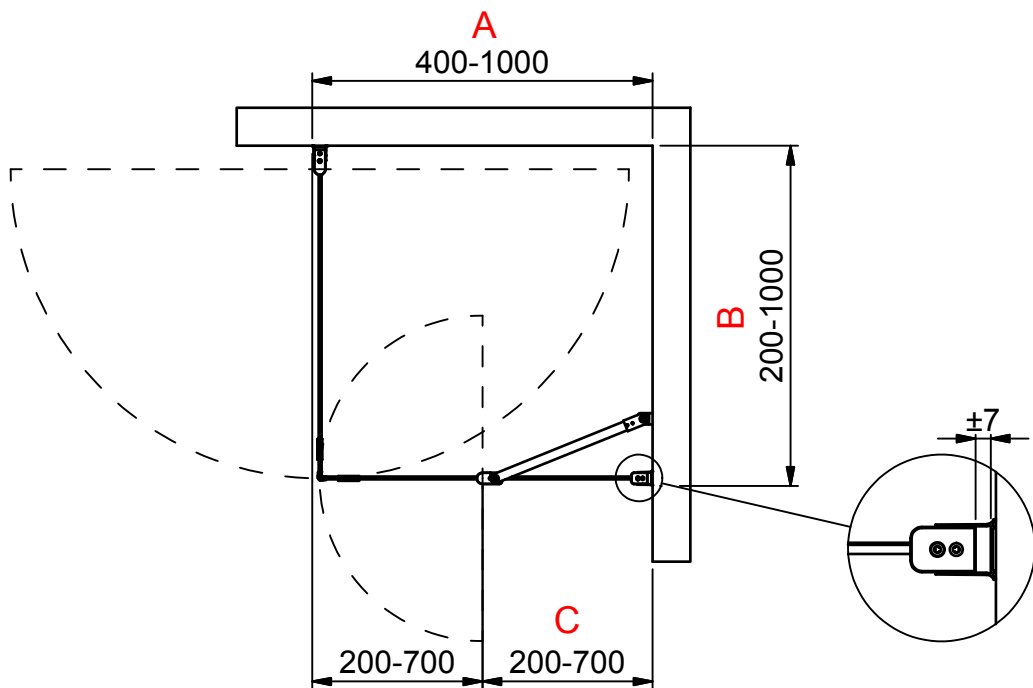
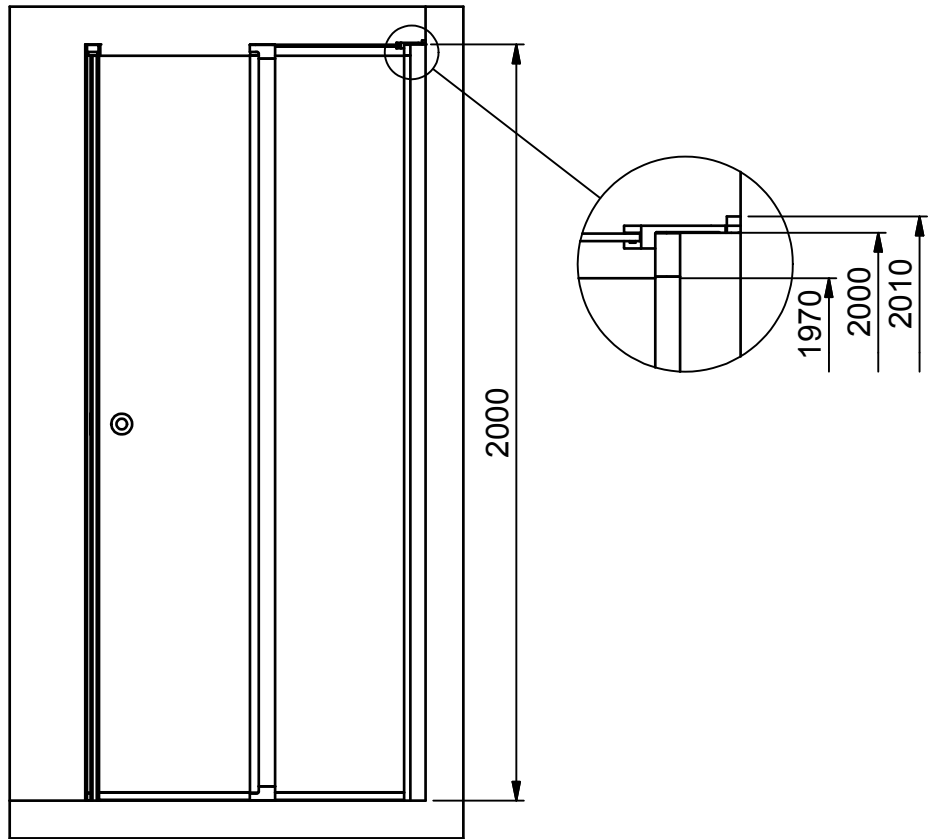

INR

Beskrivning
LINC Model 14 Left

Ritad av
CJN
Datum
2017-04-18

Ritningsnr
20019.01
Revision
B